

CM.031C CM.031D

Users restricted to
18 years of age or older
使用年齡對象18歲以上

AUTO ELECTRIC GUN



CM.031C



CM.031D

1. Silencer	1. 消焰器	42. Inner barrel	42. 槍內管
2. Front gun tip	2. 槍頭	42A. 031D Inner barrel	42A. 031D 槍內管
1A. 031D Silencer	1A. 031D 消焰器	43. Cocking lever	43. 拉手
2A. 031D Front gun tip	2A. 031D 槍頭	44. Spring (Ø0.45×Ø0.45×139×54T)	44. 壓簧 Ø0.45×Ø0.45×139×54T
3. Front sight	3. 前準星	45. Spring located slice	45. 拉手限位塊
4. Silencer fix stalk	4. 消焰器固定軸	46. Gun body cover release	46. 槍身按鍵鐵條
5. Spring (Ø0.4×Ø3.9×16×12T)	5. 壓簧 Ø0.4×Ø3.9×16×12T	47. Gun body cover	47. 槍身蓋
6. M3×6 Screw	6. M3×6 鑽孔	48. Gun barrel connect link	48. 槍筒管卡祇
7. M3×5 CMHO inner hexagon 2.5mm	7. M3×5 CMHO 圓柱頭內六角2.5mm	49. Main gear box	49. 保箱
8. Ø2.5×16.5 shaft	8. Ø2.5×16.5 單花鐵軸	50. Fier selector	50. 發彈調節片
9. Lead windpipe	9. 導氣管	51. Outer fire selector	51. 發彈調節器外扣祇
10. Up gun guard cap	10. 上護木前蓋	52. M4×10 TMHO	52. M4×10 TMHO
11. M3×3 Scren	11. M3×3 鑽孔	53. Fire selector ring	53. 發彈調節器卡環
12. Up gun guard	12. 上護木	54. Fire selector copyy barrel	54. 發彈調節器銅管
13. Up gun guard back cap	13. 上護木後蓋	55. Located slice	55. 定位卡祇
14. Down gun guard front cap	14. 下護木前蓋	56. Gun body	56. 主體
15. Down gun guard	15. 下護木	57. M3×8 KMHO	57. M3×8 KMHO
16. Decoration	16. 裝飾條	58. Gunstock lockpin	58. 槍托鎖扣
16A. 031D Decoration	16A. 031D 裝飾條	59. Lockpin spring (Ø0.8×Ø0.4×16.4×10T)	59. 大鎖扣壓簧 Ø0.8×Ø0.4×16.4×10T
17. Out gun barrel	17. 槍外管	60. Side rail	60. 側軌
17A. 031D Out gun barrel	17A. 031D 槍外管	61. M3×6 TMHO inner hexagon 2mm	61. M3×6 TMHO 內六角2mm
18. Left Hop up seat	18. 左退祇座	62. Rigger loop	62. 扳機圈
19. Right Hop up seat	19. 右退祇座	63. M3×8 PMHO	63. M3×8 PMHO
20. Up gun guard located nail	20. 上護木限位釘	64. Gun grip	64. 手把
21. M3×5 KMHO	21. M3×5 KMHO	65. M4×5 TMHO	65. M4×5 TMHO
22. M3×14 PMHO	22. M3×14 PMHO	66. Gunstock	66. 槍托
23. M3×8 PMHO	23. M3×8 PMHO	67. Gunstock joint shaft	67. 槍托管正鐵軸
24. Spring (Ø0.4×Ø3.4×18×18T)	24. 壓簧 Ø0.4×Ø3.4×18×18T	68. Wire	68. 電線
25. Staff guage panel	25. 標尺鐵片	69. Magazine cover	69. 彈盒外殼
26. Staff guage	26. 標尺	70. Magazine rear cover	70. 彈盒後蓋
27. Staff guage release spring	27. 標尺按鍵彈簧座	71. Ø2×21.5 shaft	71. Ø2×21.5 花軸
28. Staff guage release	28. 標尺按鍵	72. Ø2×251.5 shaft	72. Ø2×251.5 花軸
29. Spring (Ø0.4×Ø3.9×7.5×6T)	29. 壓簧 Ø0.4×Ø3.9×7.5×6T	73. Right trajectory	73. 右彈道
30. HOP-UP	30. 過祇	74. Left trajectory	74. 左彈道
31. Rubber selector	31. 橡膠調節片	75. Gear	75. 上鏈牙輪
32. Selector	32. 過祇調節片	76. Clockwork spring base +clockwork spring +clockwork spring cover gear	76. 發條座+發條+發條蓋牙輪
33. Gun barrel connect link	33. 槍管接祇	77. Driver	77. 傳動牙輪
34. Block	34. 扣手塊	78. Gear	78. 送祇輪
35. Nail	35. 管正釘	79. Gear spring	79. 送祇輪扭簧
36. Hop-up cylinder rubber	36. 調節圓柱橡膠	80. Magazine cover	80. 彈盒蓋
37. M2.5×6 PWAHO d=Ø5.0	37. M2.5×6 PWAHO d=Ø5.0	81. Bullet block	81. 卡彈片
38. Ø2.0×4 PWAHO d=Ø5.0	38. Ø2.0×4 PWAHO d=Ø5.0	82. Spring (Ø0.4×Ø3.9×7.5)	82. 彈簧 Ø0.4×Ø3.9×7.5
39. Ø2.0×4 KBHO	39. Ø2.0×4 KBHO	83. Ø2.6×10 PAHO	83. Ø2.6×10 PAHO
40. Hop-up rubber	40. 過祇橡膠	84. Ballistic transition nail	84. 彈簧過渡釘
41. Inner barrel sleeve	41. 槍管銅套		

ELECTRIC AIR GUN 電動汽彈槍

Name	名稱	CM-031C	CM-031D
Overall length	全長	715mm/945mm (when stock is extended)	605mm/835mm (when stock is extended)
Weight	重量	3280g Including battery 3280克 包含電池	3260g Including battery 3260克 包含電池
Magazine capacity	裝彈數	500 rounds 500發	500 rounds 500發
Bullet	子彈	6mmBB bullets 6mmBB彈	6mmBB bullets 6mmBB彈
Initial bullet speed	初速度	102m/sec (0.2g bullet) 102米/秒 (0.2g 子彈)	102m/sec (0.2g bullet) 102米/秒 (0.2g 子彈)
Full auto shooting speed	連射速度	700 to 850 rounds/min 700-850發/分	700 to 850 rounds/min 700-850發/分

在操作之前必需讀熟這些說明書
Always read through this manual before operation.



警告 WARNING



18岁以上年齡才能使用
Only for 18 years
of age or older

18岁以上年齡才能利用這支汽槍比賽使用
Operation of this air gun for competition use is restricted to users of 18 years of age or older.



注意受損傷
Injury caution

因為BB彈能達到50-60米範圍，不小心的射擊將可能導致眼睛受損傷或其它傷害。
Since plastic BB bullets reach 50 to 60 meters, careless shooting may cause eye damage or other injuries.



注意熟讀警告指示手冊
Careful reading of
Handling cautions
and
Instruction manual

在操作之前要細心讀熟警告手冊和指示手冊操作汽槍時必須認好警告指示
Always read through this HANDLING CAUTIONS AND INSTRUCTION MANUAL carefully before operation.
Operate the air gun with full recognition of warnings and cautions.

WARNING
警告

Always wear eye protective gear. 玩槍時，請始終戴着眼保護裝置。

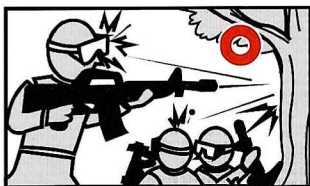

When shooting the air gun for a target or game, you and all participants must wear goggles or other eye protective gear, also paying attention to ricochets. (Pay sufficient attention also to third personnel other than participants.)

當使用汽槍射擊目標或遊戲時，你和所有的參與者都必須戴着防護眼鏡或其它眼保護裝置，同時要注意子彈的彈跳方向。（而且要特別注意不能射向遊戲者以外的第三者。）

You may be punished if you are shooting for a practical joke.

如果用汽槍開惡意玩笑，可能會受到懲罰。

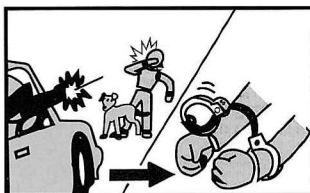

You may be punished if you damage public or personal properties or injure a person or animal even if you are shooting for a practical joke. Always observe manners and enjoy healthy sport shooting.

如果你損害公共的或私人的財產，或者傷害人或動物，即使你是在進行射擊實踐遊戲，你也會受到懲罰。請始終守規定，享受有益健康的運動射擊。

Never disassemble or modify the air gun. 避免拆除或修改該氣槍。



This air gun is manufactured under consideration of appropriate performance and operability. Disassembling or modifying the gun may generate danger or adversely affect the performance. So, avoid disassembling or modifying the air gun.

該汽槍是根據適當的性能和操作而製造的。拆除或改裝汽槍可能產生危險或者逆反操作。因此要避免拆除或改裝該汽槍。

Never look into the gun muzzle. 禁止直接目視槍口。

Never shoot at any human or animal. 禁止射擊人或動物。



Do not look directly into the muzzle to avoid accidental discharge of BB. 不要直接地看槍口，避免BB彈意外射擊。

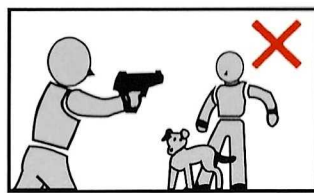

Never aim or shoot a person or animal as the target. Always attach the protective plug to the muzzle. 不可把人或動物當作目標瞄準或射擊。

- Make sure to operate an air gun after recognizing its features.
- We are not responsible for any accidents, events, injuries or repair costs arising from wrong operation and handling or by modification and disassembly of the gun.
- 請確保在了解其特徵之後再使用該汽槍。
- 對於任何由錯誤操作或改裝和拆卸汽槍所引起的意外事故，突發事件，受傷或修理費用，我們將不負有責任。

THOROUGHLY UNDERSTAND THE WARNINGS AND CAUTIONS FOR SAFE OPERATION.

詳細閱讀說明書中要注意的操作，才能安全的使用本產品。

Read through this manual before shooting paying special attention for safe operation.

在使用前，請仔細閱讀本說明書，以便安全的操作本產品。

Always observe warnings and cautions strictly. Failing to do so may cause injury, accidents, or damage to the gun.

要嚴格遵守本產品中的警告及注意事項。否則將造成傷害或是槍支的損害。

1 Charging the battery (Battery and charger sold separately.)

電池充電器（電池和充電器有單獨出售）

- Use the specified battery for the gun. 8.4V, 1100mAh Hyper Command Mini Battery. Avoid use of non-standard or other brand name batteries. Otherwise, the originally designed functions will not be obtained.

使用槍支專用的電池。8.4伏，1100毫安小電池。

Hyper Command
請避免使用非標準或其他品牌的電池，否則將達不到設計要求。

請使用專用電池
Use the specified battery

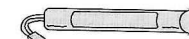

• 8.4V Type Mini Battery
8.4V的小電池



• Exclusive Charge for Mini Battery
小電池專用的充電器

CAUTION The SD and Mini Battery can not be used.

△注意 不能使用SD和小類型的電池。

- Use the specified battery charger which is applicable to the above battery. The charger Exclusive Type ac Speed Charger. 使用上述電池專用充電器。
- The battery's capacity power is increased with use of the Exclusive (battery) Discharger (Sold separately). 使用專用的電池充電器會增加電池的能量。（有單獨銷售）
- Use the correct battery and charge according to respective instruction manuals. We will not be held responsible for any accidents or damage caused by wrongful operation or usage of non-specified batteries. 請根據使用手冊使用標準的電池和充電器。如果沒有按照說明書操作或者使用非專用的電池而引起的事故或傷害，我們將不負任何責任。

2 THE NAME OF THE PARTS (For details, see the following pages.)

各部分名稱（具體請參照下面）

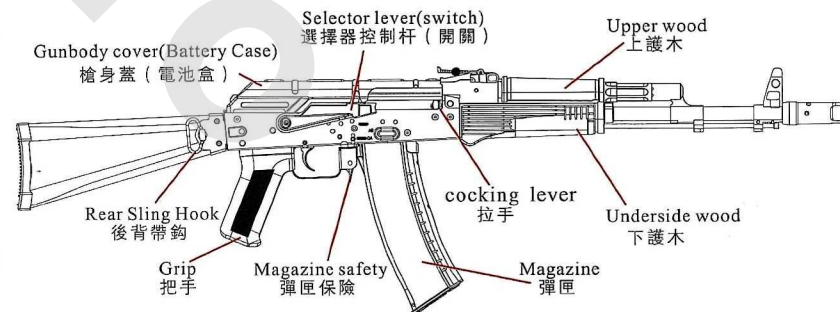

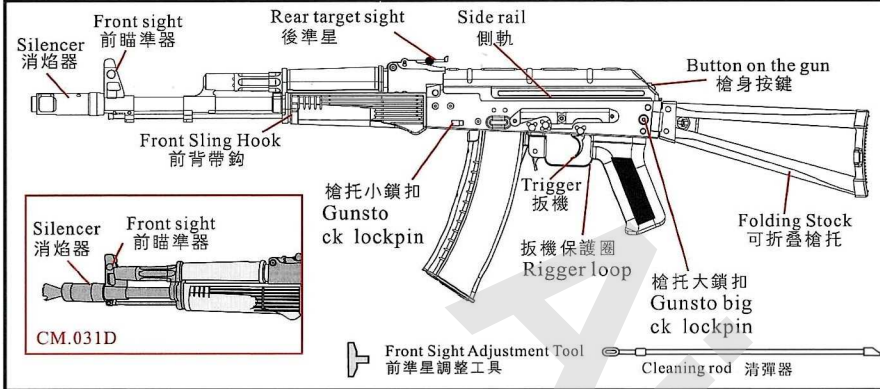

3 Selector lever and safety setting 選擇控制杆和安全裝置

- To prevent malfunction of the switch do not change the selector lever from semi to full auto while pulling the trigger.
為防止開關發生故障，在按扳機時，不要將選擇控制杆從半自動改到全自動。

CAUTION Set the selector lever correctly in position otherwise, malfunction may occur.
將選擇控制杆設置在正確的位置，否則將會發生故障。

- Safety setting (the trigger cannot be pulled.) 安全裝置 (不能按下扳機)
When you are not firing the gun or during storage always set the selector to the safe position.
當你不射擊或在裝子彈時，請將選擇器設置在安全位置。

- Fully automatic (automatic firing)
全自動 (連擊)
The gun will fire automatically while the trigger remains pulled.
按緊扳機，汽槍將自動射擊。

- Semi automatic
半自動
The gun will fire one shot each time the trigger is pulled.
每按一次扳機，汽槍將發射一發子彈。

4 Setting the Battery (Set the battery after charging) 安裝電池 (用充電器先把電池充滿)

- Remove the receiver from its rear while pressing the receiver top catch button.
按下槍身蓋頂部的按鈕，從後部卸下槍身蓋。

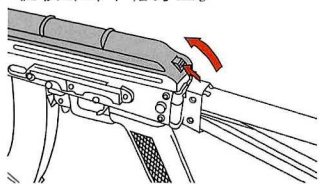

- Connect the battery to the cord that is accessible from the hole under the rear sight. Press in the battery with its protrusion facing to the left.

將電池接在後端孔伸出的錢，電池突出部分朝向電池左邊并按下。

The protrusion must be on the left side.
突出部分必須置于左邊

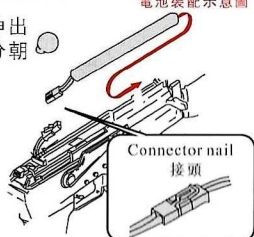

- Reinstall the receiver top in the reverse order of removal procedure in step(1). Align the lead edge of receiver top to the groove under the rear of receiver top, aligning to the groove shown below.
按步驟1的卸槍身蓋程序的相反順序重新安裝槍身蓋，槍身蓋的邊和槽邊堆砌，按槍身蓋後邊。

CAUTION When receiver top is set correctly, the catch button ejects out.
當按鍵彈出時，表示槍身蓋安裝正確。

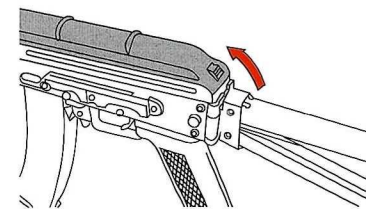

5 SETTING THE MAGAZINE 安裝彈匣

- Open the cover of the magazine
打開彈匣蓋

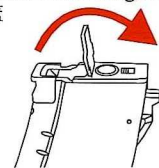

- Insert 6mm BB bullets into the loader (500 bullets can be loaded)
將6mm BB彈裝入彈匣 (可裝入500發BB彈)

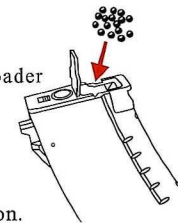

- Set the magazine upward.
Install the magazine as illustration.
從上方安裝彈匣。可以按箭頭所示步驟安裝彈匣。

- Replace the magazine cover
蓋上彈匣蓋

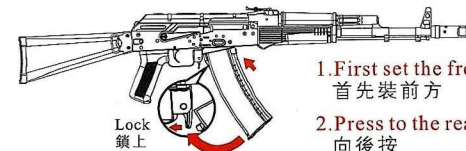
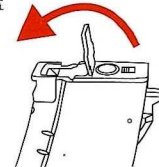

1. First set the front.
首先裝前方
2. Press to the rear.
向後按

3. Press the release lever towards the trigger to lock.
朝扳機方向按下并鎖定。

- Move the gear with hand clockwise until it is fully wound, and the bullets will be sent up automatically. (It can send about 150 rounds automatically.)
以順時針方向扳動牙輪，直到上滿鏈，子彈就會自動往上送。
(能自動送彈約150發)

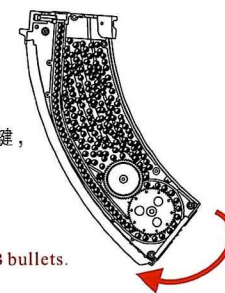

CAUTION

The magazine is capable of Containing 500 BB bullets.
彈匣可裝500發BB彈。



Magazine stopper relief rib.
彈匣自動裝置解除鈕。
Slide the rib in the arrow direction to remove remaining BB bullets. (Be careful since BB bullets may jump out.)
按箭頭方向移動按鈕取出剩餘BB子彈。(小心BB子彈可能會跳出)

CAUTION

Always use the BB bullets for the air gun. We shall not be held responsible for any damage or accidents arising from the use of bullets supplied by other manufacturers.

這種氣槍祇能使用標準的6mmBB彈。如果使用其他供應提供的子彈而引起的損害和事故，我們將不負任何責任。

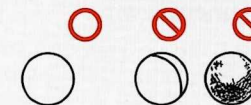

6 Moveable Parts 可動的零件

CAUTION △注意

Be careful so that your skin and fingers do not get caught in the folding parts.

小心你的手指和皮膚不要被折疊的部分傷到。

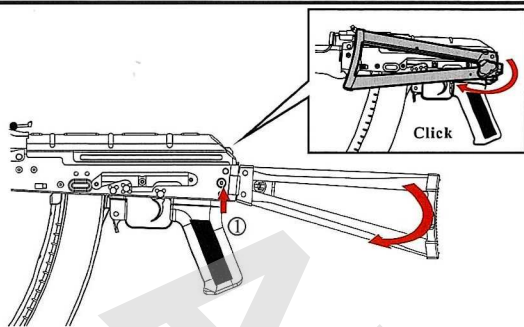

Press the gun stock release button ①, move forward the gun stock
按下槍托鎖定鍵①,然後槍托就可以按箭頭方向折疊到前面

INSTALLATION OF THE ELIMINATE BLAZE IMPLEMEN 消焰器的安裝

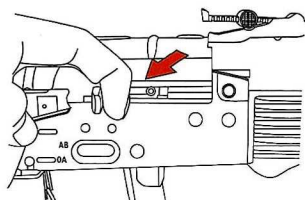

Variable hop-up adjustment lever
可變化的跳動調整杆

- ① While pressing the lock button.
按下鎖定鍵
- ② 旋轉消焰器
Revolve Silencer

The eliminate blaze implement is fixed by counterclockwise as in the case of real gun
與真槍一樣,消焰器是用反向綫固定的。

- Insert the front sight adjustment tool in the front sight and turn it for adjustment.
將前準星調整工具插進前準星裏,然後轉動以作調整。

CAUTION △注意

Be careful so as not to loose the adjustment tool.
注意不要鬆開調整工具。

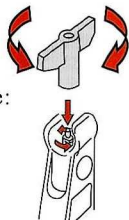

Counterclockwise:
lower sight point
順時針方向:
降低瞄準點

Clockwise:
higher sight point
逆時針方向:
提高瞄準點

- The cocking lever can be moved.

拉手是可移動的

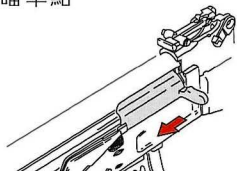

- Variable hop-up adjustment lever

可變化的跳躍調整杆

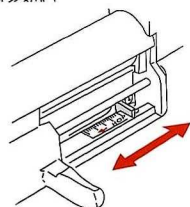

● REAR SIGHT ADJUSTMENTS

後瞄準器的調節

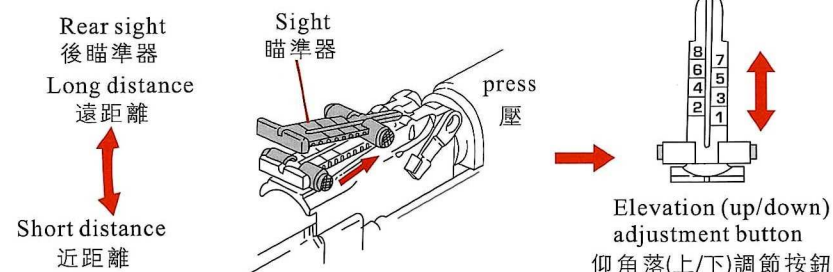

The 031 series rear sight is a tangent type which is adjusted vertically according to distance to the target.

031系列汽槍的後視屬於相對獨立的類型。它是根據目標的距離垂直方向調整的。

Press the adjust button and slide it forward or backward to move the sight up or down. The larger the number, the longer the distance to the target.

按下調整按鈕向前或向後滑動以調整視野,數字越大,距離目標就越遠。

7 Firing (Confirm your shooting are a is safe before beginning firing.) 射擊 (射擊前,確保射擊地方是安全的)

- ① Set the selector lever to Semi or Full Auto.
把控制杆從設置在半自動或自動的位置
- ② Pull the trigger
按住扳機

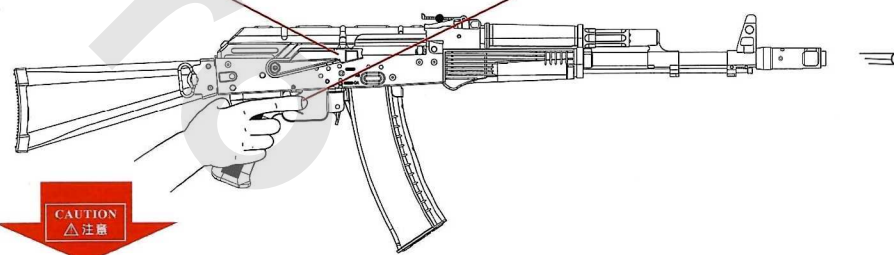

A blank firing may occur ar triggering after the magazine,this is the normal operation of the gun.
當在你裝上子彈開始射擊時,可能會有空白的射擊,這是屬於槍的正常的情況。

CAUTIONS ON MOTOR AND BATTERY 發動機和電池使用注意事項

- Charge the battery if the firing cycle becomes slow.
當射擊速度變慢，請充電。
- Give the air gun a rest for 5 to 10 minutes after firing about 500 rounds, in order to ensure long service lives of the motor and battery.
爲了確保發動機和電池的壽命，在射擊500發後，給氣槍5-10分鐘的間歇。

WHEN BULLETS ARE CLOGGED 當子彈阻塞時，應採取的措施

- If bullets are clogged, remove them and apply a few drops of silicone oil in to the chamber from the magazine entrances shown or spray silicone oil for 0.5 or 1 sec, to obtain smooth continuous.
假如子彈阻塞，把子彈取出來，爲了以後順利的射擊，請從子彈匣的入口處往槍膛滴上或噴上幾滴潤滑油。

AFTER OPERATION 使用之後

- Remove the magazine and dry fire the gun in the semi auto mode directing the muzzle to a safe direction. (Otherwise the spring may be weakened). Set the selector to the Safe position.
把子彈匣取出，在半自動的模式下，把槍對着安全的地方射擊。(否則，彈簧彈性可能會變弱)把選擇器調到安全(safe)這一檔。

- Bullets may remain in the chamber even if the magazine contains no bullets (or if the magazine is not connected) (Two or three bullets may drop from the magazine, this is the normal operation of the gun.)
即使彈倉裏沒有子彈，(或彈倉被取出後)子彈也可能會留在槍膛裏。

- Always disconnect the battery and attach the protective cap whenever you do not operate the air gun.
當你使用氣槍時，必須斷開電池。

Always attach the protective cap during storage.

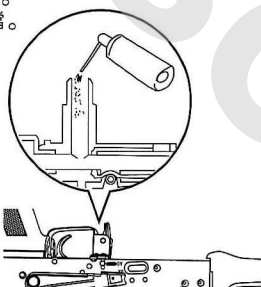

CAUTION 注意

- **There are possible cases that no firing occurs after pulling the trigger in the semi-auto mode. In this case, do not pull the trigger furiously. Fire 5 to 6 shots in the full auto mode and then return to the semi auto operation.**
在半自動的狀態下，有可能你按住扳機之後，子彈沒有射出來。遇到這種情況，不要猛烈地按住扳機，在全自動的狀態下，射擊5到6發，然後再調到半自動的狀態下嘗試。
- **Smell may be generated from motor for a while when a new air gun is operated. This is the normal operation of the gun.**
剛開始使用新氣槍時候，可能會有一股味道。這股味道是電機運轉時產生的，這種情況屬於正常現象。
- **The hopping up operation may be unstable for 200 to 300 rounds after using silicone oil, this is the normal operation of the gun.**
使用潤滑油之後，槍支的前200到300發可能不太穩定，這種情況屬於正常現象。

8 TROUBLE CLINIC (TROUBLE SHOOTING) 故障診斷 (維修之前請確認是否發生故障)

SYMPTOM 癥狀	CAUSE 原因	ACTION 方法
No operation at all 無法操作	Select or is set to safety. 選擇(器)杆調在安全這一檔(Safety)	Set the selector lever to Semi or Full Auto 把選擇(器)杆調在半自動或全自動檔
	Battery is not charged. 電池沒有充電	Charger the battery 給電池充電
	Battery connector is disconnected. 電池連接器被斷開	Connect the connector 連接連接器
	The + and - or battery connector is revers. 電池的正負極連接器倒置	Connect the connector correctly (check the fuse) 正確連接連接器(檢查保險管)
	Fuse is blown out 保險管爆裂	Relace the fuse (See page) 重新換上保險管(見第12頁)
	Expired motor life (50,000 to 60,000 rounds) or poor electrical connection. 50,000到60,000發時，馬達壽命可能耗盡或電線連接老化	Replace the motor (purchasing from your dealer or us) or check and repair the contacts 換新的電機(可向經銷商或我們購買)，或者仔細檢查和修理電線接觸點
Although motor is removing, bullets jump out. 電機沒有發生故障，但子彈無法正常發射。	Bullets are clogged in the magazine 子彈阻塞在彈倉裏	Insert the charging rod into the magazine and move up and down a few times to remove clogged bullets 用裝載杆插進彈倉裏，上下移動幾次，把阻塞的子彈移出
	Bullets are clogged in the chamber 子彈阻塞在(槍)膛裏	Remove clogged bullets using the cleaning rod 用(槍支的)清彈器把阻塞的子彈取出
	Faulty gear 齒輪壞了	Purchase the replacement gear from your dealer and repair 向經銷商購買新的齒輪後進行維修
Impossible full-auto operation. (Automatic firing) 不能連發(子彈無法射出)	Insufficient battery power 電池電量不足	Charge the battery 給電池充電
	Faulty bullet feed of magazine 彈倉裏的子彈裝錯	Repair clogging the magazine 清理彈倉裏的堵塞物
Impossible semi-auto operation. (Single shot) 不能單發	Poor electrical connection 電線連接不好	Consult your dealer or us for overhaul maintenance or repair 向經銷商諮詢如何維修
	Deviation in gear timing 齒輪調配偏離	Set to semi auto firing 5 to 6 rounds in full auto 在全自動這一檔射擊5到6次後調到半自動檔

Use of poor quality BB bullets will cause problems. Never disassemble or modify the gun
如使用低質量的BB彈將出現問題。不要拆卸或修改槍支。

SYMPTOM 癥狀	CAUSE 原因	ACTION 方法
Impossible semi-auto operation.(Single out) 不能半自動操作	Insufficient battery power. 電池電量不足	Charge the battery 給電池充電
Automatic firing become shorter. 連發射擊變慢	Insufficient battery power. 電池電量不足	Charge the battery 給電池充電
Shooting distance become shorter 子彈射程變短	Worn or damaged chamber packing (槍)膛材料太舊或壞了	Consult your dealer or us for overhaul maintenance or repair. Replace the chamber packing. Piston packing(O-ring)and piston assembly. 向經銷商諮詢如何維修。重新換上槍膛材料, 活塞材料(O形圈)和活塞組裝件。
	Worn or damaged chamber packing.(O-ring) 槍膛材料(O形圈)太舊或壞了	
	Deteriorated piston spring. 活塞彈簧損壞	
	Faulty BB bullets. (Too small or heavy) BB子彈不合格(太小或太重)	Use the genuine BB bullet 使用質量合格的BB彈
	Faulty gear. 齒輪壞了	Purchase the replacement gear from your dealer and repair 向經銷商購買新的齒輪後進行維修
Too loud operating noise 噪音太大	Gear problem caused by too many blank firing or worn or damaged gear. 太多的空白射擊導致齒輪出現問題或者齒輪老化或損壞。	Consult your dealer or us for overhaul maintenance, part replacement(gear etc)or repair 向經銷商諮詢如何維修, 零件替換(齒輪等)
	Gear problem caused by too many blank firing or worn or damaged gear. 太多的空白射擊導致齒輪出現問題	
Bullets being follen out from barrel end. 子彈從槍管頭彈出	Worn or damaged chamber packing (槍)膛材料太舊或壞了	Turn the hop adjustment lever toward HOP 把調節杆調到HOP位置
	No hop setting 沒有設置HOP	
	Faulty BB bullets. (Too small) BB子彈不合格(太小)	
Being wet or drop into water.(rain) 槍支弄濕或掉進水裏(雨淋)	Stop operation immediately, disconnect the battery, wipe off water from water from inside themain body and the battery, and after complete dry, carry out trial firing, if no operation or malfunction is detected, consult your dealer or us for repair. 立刻停止使用, 斷開電池, 把電池和槍支內部的主要部分擦幹, 等槍支完全幹了之後, 再嘗試射擊。假如無法使用或者發現故障。向經銷商或我們諮詢如何維修。	

9 VARIABLE HOP UP SYSTEM 可變化的Hop Up系統

By producing a back-spin to the BB bullets, this system allows for straighter and longer distance shooting than normal air gun. Unlike the fixed type, the variable hop up system permits one-touch adjustments using the dial and lever, making it an ideal hop up system.

通過使子彈逆轉, 可以使射擊比一般的氣槍射得更直和更遠。不像其他的固定類型的氣槍一樣, 可變化的Hop Up系統可以使用轉盤和調節杆來進行調整。

▶ Adjustment Procedure(Adjust by carry out trial firing)
調節程序(通過試射擊來進行調節)

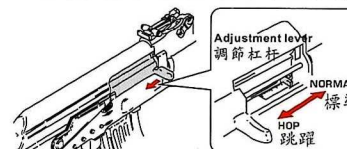

Gradually turn the adjustment dial towards Hop to give hop up to bullets. (The best setting is where bullets fly horizontally.)
把調整鍵慢慢移向跳躍方向。(最佳設置為子彈水平方向射出)

- Turning excessively adversely affects the trajectory. So stop turning the hop adjustment lever when bullets fly horizontally.
向相反的方向用力的扭轉可能會影響到彈軌。因此, 如果子彈能夠水平射出, 就停止扭轉調節杆。
- The best position is where the bullets fly horizontally, and the longest flying distance is obtained.
最佳的位置是子彈水平方向射出, 此位置使子彈達到最遠射程。

Too much hop-up (return the lever towards NORMAL)

過度上旋(將調節杆撥回正常位置) X

Best position
最佳位置 O

Not enough hop-up (return the lever towards NORMAL)

上旋不到位(將調節杆撥回正常位置) X

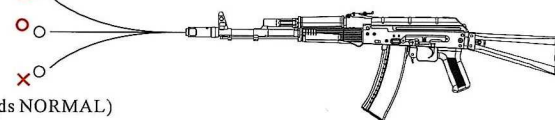

OPERATIONAL CAUTION
(strictly observe the following caution)

操作注意事項:(要注意以下的事項)

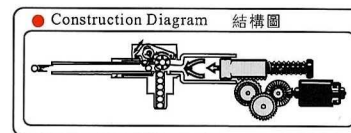

- Moving the lever too much towards HOP causes bullets to clog. Firing the gun with clogged bullets damages the piston and gears.
調節杆過度調向跳躍方向會導致子彈堵塞, 子彈堵塞的情況下射擊會導致活塞和齒輪的損壞。
- If bullet clogging occurs, immediately stop firing the gun, return the hop lever to the Normal position and remove clogged bullets using the cleaning rod.
如果子彈堵塞, 請立即停止, 把跳躍杆調至正常位置, 用清潔器取出堵塞子彈。
- Make sure to return the hop adjustment lever to the Normal position when removing clogged bullets or cleaning. (Otherwise, the chamber packing is damaged.)
在取出堵塞子彈時或進行清潔時, 要把HOP調節杆調到正常的位置(Normal)(否則可能會損害槍膛)
- Never use used or dirty bullets. (Otherwise, the chamber becomes dirty, resulting in unstable hopping up.)
不要重複使用子彈或使用臟子彈。(否則彈膛會變臟, 從而導致跳躍的不穩定)
- When about 10000 rounds are fired, spray silicone oil into the chamber for 0.5 to 1 dec. (See 11 on page 8. The hopping up operation may be unstable for 200 to 300 rounds after spraying the silicone oil, this is the normal operation of the gun.)
射擊大約10000粒子彈, 用硅油噴彈膛0.5-1秒。(在噴硅油後, 200-300輪射擊的跳躍操作會不穩定, 這種情況屬於正常現象。)
- We will not be held responsible for any damage or accidents arising from wrongful operation, disassembly and modification of the gun. Any costs for repair of such damage shall be paid by the user.
由于錯誤操作, 重新組裝或改裝氣槍所引起的損壞或意外, 我們一律不予負責, 由此產生的維修費用由用戶自行承擔。

CAUTION

- If the hop-up is adjusted excessively causing clogging of bullets, immediately stop operating the gun. Return the lever to Normal, fire 2 or 3 shots and readjust.
假如hop-up過分地調整可能會導致子彈的阻塞，遇到這種情況，立刻停止使用，把調節杆調至正常射擊(Normal)狀態下，射擊2到3發，然後重新調整。
- Since a precision tight barrel is used, use of dirty bullets or those with burrs causes clogging of bullets and possible fatal damage to the mechanical box and system.
由于槍管非常精密，如果使用臟的子彈可能會導致子彈阻塞和很致命的損壞槍支。

WARNING

- Never hold the gun side ways as the BB bullets will curve tight or left. This is due to the HOP-UP system.
不要從側面握住槍支進行射擊，因為BB子彈射出時可能會偏左或者偏右。

**WHEN HOPPING UP IS IMPROPER**
跳躍不正常現象

SYMPTOM 癥狀	CAUSE 原因	ACTION 方法
Bullets flying upwards. 子彈向上飛	Too much hop setting (hop)設置太大	Gradually return adjustment lever towards Normal. 把調節杆逐漸地調到正常狀態。
Short flying distance of bullets (less hopping up effect). 子彈射程太短 (短于跳躍應有效果)	Too much hop setting (hop)設置太大	Gradually return adjustment lever towards Normal. 把調節杆逐漸地調到正常狀態。
	Hop packing contaminated by oil or dirt. Hop包裝被油迹或污垢玷污	Fire bullets equivalent to 4 or 5 magazines or clean the chamber using cleaning rod. 用(槍支的)清彈器清潔槍膛。
	Worn or damaged hop packing Hop包裝太舊或被損壞	Purchase the replacement part at your dealer or from Marui and replace it. 向經銷商或我們購買所需配件，更換hop裝置。
Cannot adjust 不能調節	Damaged adjustment lever or other parts 調節杆或其他部件損壞	Purchase the replacement part at your dealer and replace it. 向經銷商購買所需配件，更換hop裝置。
Frequent bullets clogging 子彈經常阻塞	Too much hop setting (hop)設置太大	Gradually return adjustment lever towards Normal. 把調節杆逐漸地調到正常狀態。
	Improper or too large sized BB bullets BB彈不合適或太大了	Use the BB bullets for Electric Gun. 使用標準BB彈。
	Dirty hop packing Hop包裝弄臟	Clean using the cleaning rod or consult your dealer for repair. 用(槍支的)清彈器清潔或者向經銷商諮詢維修。

10 MAINTENANCE
保養**1. Fuse Replacement Procedure**
更換保險管

4-1 methods of press the P3 open the gun body cover, then can replace then already burned-out insurance a tube

按P3 4-1方法打開槍身蓋，然後便可更換已燒壞的保險管

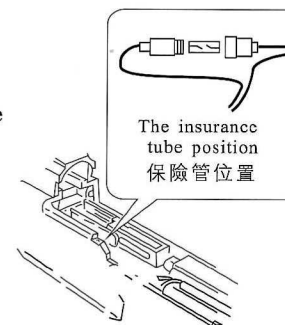
**Glass tube fuse 保險管**

You can buy it at a near-by electric shop or gas station. You can buy it at a near-by electric shop or gas station. 你可以在附近的五金店或電器店買到它。
20A Fuse common for electric gun series.
常用於電動槍系列的20A保險管。

2. Remove the obstruct bullets

拆卸堵塞子彈

- ① Insert the cleaning rod into the bore. 沿槍管的內邊緣插入清彈器。
- ② Be careful so that the angled part of the cleaning rod faces down, and remove clogged bullets. 確保清彈器的角部分向下，并清楚堵塞子彈。

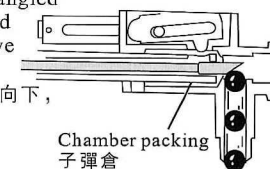
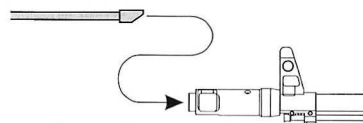

The ornamental can not be used for cleaning the obstruct bullets.

附在氣槍上的裝飾條模型不能用于清楚堵塞子彈。

Make sure to insert the cleaning rod AFTER returning the hop up lever to the Normal position. (Hop-OFF)

確保跳躍調整杠回復到正常位置才能插入清彈器。

**3. Maintenance When Bullet Speed Become Low**

當子彈速度變慢時怎樣維修

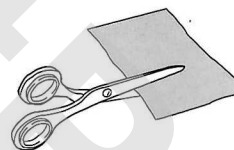

Cotton cloth 綿布
Width: Approx 10mm 長度: 大約25-30mm
寬度: 大約10mm



Wind the cut cotton cloth.
轉動把綿布卷起來

Cut the cotton to the size shown. Adjust the length accordingly so that it can be inserted smoothly into the barrel.

將棉線剪成如圖所示才大小。適當地調整長度，以便于將其順利地插進槍管裏。

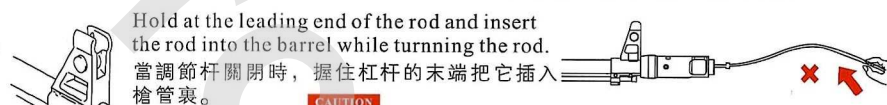

Hold at the leading end of the rod and insert the rod into the barrel while turning the rod.

當調節杆關閉時，握住杆杆的末端把它插入槍管裏。



- Inserting the rod will be difficult if you hold rod at the end. 假如你緊握清彈器的末端，清彈器插進去可能會很困難。

Hop chamber packing
彈跳槍膛封墊

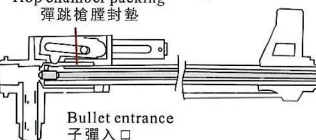

Bullet entrance
子彈入口

- Since the chamber is a precision component, avoid use of used BB bullets. 由于槍膛是一個精確的部件，請避免使用用過的BB彈。

- Always carry out maintenance AFTER returning the hop up lever to the Normal position. (Hop-OFF) 在將上旋杆撥回正常位置後，才能進行維修保養。

Apply a few drops of silicone or Teflon oil.
滴幾滴硅樹脂或特氣輪油

- Drop a few drops of silicone oil or Teflon oil from the bullet entrance, insert BB bullets into the magazine and fire bullets equivalent to 1 or 2 magazine.
從子彈的入口處滴幾滴潤滑油。把BB子彈裝進彈倉，射擊1或2次。
- To complete the cleaning. Use the cleaning rod (with cotton) as shown below, to remove excess oil. 使用槍支清彈器按照以下說明除去多餘的潤滑油。

4. FINE ADJUSTMENT OF GEAR ENGAGEMENT

齒輪齒嚙的微調

Remove the screw from the grip bottom.

在把手底部擰開螺絲。

M3 hexagon wrench

M3六邊形扳手

Insert M3 hexagon wrench into the screw hole to adjust.

將M3六邊形扳手插入螺絲孔裏調整。



CAUTION

△注意

Only when the motor noise becomes high after operations for a long period of time, conduct the fine adjustment as shown.

若使用時間過長，電機發出很大的噪音時，請按如圖所示對電機進行微調。

Hold the grip during adjustment. Otherwise, the main body will drop since the grip set screw is removed.

在調整時要握緊把手。否則，主體會因為固定把手的螺絲被取下來了而掉出來。

CAUTION

△注意

- It is recommended to lock the adjustment screw by a screw locking agent or instantaneous adhesive after adjustment of the motor position is complete.
建議你在馬達位置調整完成後，使用螺絲釘固定器或瞬間黏合劑固定調整螺絲釘。
- Normally, do not attempt to adjust.
通常不要隨便調整。
- Be careful as not to overly tighten the screw as it will damage the gun.
注意不要過度擰緊螺絲釘以免損壞氣槍。

